

Serie 600 - 610

Centralini modulari da parete
Wall mounting modular enclosures

Coffret montage en saillie
Cuadros de superficie

Rif. di tipo Type Ref.	Articolo Item Article Codigo	N. Moduli Module No. N. Modules N. Módulos	Descrizione Description Description Descripción	Dimensioni Dimensions Dimensions Dimensiones	Potenza dissipabile Dissipating power Puissance Potencia disipada (W)
60004	60004	4	con porta trasparente	150x170x100	11
60004	60004B	4	con porta trasparente - bianco	150x170x100	11
60008	60008	8	con porta trasparente	200x180x100	14
60008	60008B	8	con porta trasparente - bianco	200x180x100	14
60012	60012	12	con porta trasparente	280x220x100	21
60012	60012B	12	con porta trasparente - bianco	280x220x100	21
60018	60018	18	con porta trasparente	400x265x130	30
60018	60018B	18	con porta trasparente - bianco	400x265x130	30
60024	60024	24	con porta trasparente	280x350x100	30
60024	60024B	24	con porta trasparente - bianco	280x350x100	30
60036	60036	36	con porta trasparente	400x400x130	47
60036	60036B	36	con porta trasparente - bianco	400x400x130	47
60054	60054	54	con porta trasparente	400x600x130	72
60054	60054B	54	con porta trasparente - bianco	400x600x130	72
60072	60072	72	con porta trasparente	420x885x150	85
60072	60072B	72	con porta trasparente - bianco	420x885x150	85
61002 (*)	61002	2	senza porta	85x130x50	5
61003 (*)	61003	4	senza porta	150x170x100	6
61004 (*)	61004	4	senza porta	140x170x100	11
61008 (*)	61008	8	senza porta	200x180x100	15
61012 (*)	61012	12	senza porta	280x220x100	23
61018 (*)	61018	18	senza porta	400x265x130	34
61024 (*)	61024	24	senza porta	280x350x100	34
61036 (*)	61036	36	senza porta	400x400x130	58
61054 (*)	61054	54	senza porta	400x600x130	79

(*) Nota per centralini senza porta: il grado di protezione IP40 (impossibilità di introdurre filo di prova Ø 1mm) si ottiene installando accessori con grado di protezione IP40, apparecchi con superficie frontale liscia o con copri foro.

(*) Note for enclosures without door: the degree of protection IP40 (impossibility to introduce test wire Ø 1mm) is obtained installing accessories with degree of protection IP40, appliances with smooth frontal surface or using hole-cover.







(*) Remarque pour les coffrets sans porte: le degré de protection IP40 (impossibilité d'introduire le fil essai Ø 1mm) est réalisée par l'installation d'accessoires avec un degré de protection IP40, les appareils avec une surface frontale lisse ou cache-module.

(*) Nota para cuadros sin puerta: el grado de protección IP40 (imposibilidad de introducir prueba del hilo Ø 1mm) se consigue mediante la instalación de accesorios con grado de protección IP40, aparatos con una superficie frontal lisa o tapas cubre módulos.



Serie 600 - 610 IP40

Centralini modulari da parete
Wall mounting modular enclosures
Coffret montage en saillie
Cuadros de superficie

							
N. Moduli Module No. N. Modules N. Módulos	RAL7035	RAL7035	RAL7035	RAL9001	Kit morsettiere Terminal blocks kit Equipment Regletas	Supporto morsettiere Terminal block support Supporto barrette Soporte regletas	Morsettiere Terminal block Barrette Regletas
2	EC61002						
4	EC61003						
4		EC61004	EC60004	EC60004B	EC6004EQ	EC67004	
		EC61004E	EC60004E	EC60004BE			1x4
8		EC61008	EC60008	EC60008B	EC6008EQ	EC67004	
		EC61008E	EC60008E	EC60008BE			1x8
12		EC61012	EC60012	EC60012B	EC6012EQ	EC67012	
		EC61012E	EC60012E	EC60012BE			1x12
18		EC61018	EC60018	EC60018B	EC6012EQ	EC67012	
		EC61018E	EC60018E	EC60018EB			1x12
24		EC61024	EC60024	EC60024B	EC6024EQ	EC67012	
		EC61024E	EC60024E	EC60024BE			2x12
36		EC61036	EC60036	EC60036B	EC6036EQ	EC67012	
		EC61036E	EC60036E	EC60036BE			3x12
54		EC61054	EC60054	EC60054B	EC6054EQ	EC67012	
		EC61054E	EC60054E	EC60054BE			4x12
72			EC60072	EC60072B	EC6054EQ	EC67012	
			EC60072E	EC60072BE			4x12

Serie 600 - 610

Istruzioni di montaggio
Installation instructions
Instructions d'installation
Instrucciones de montaje

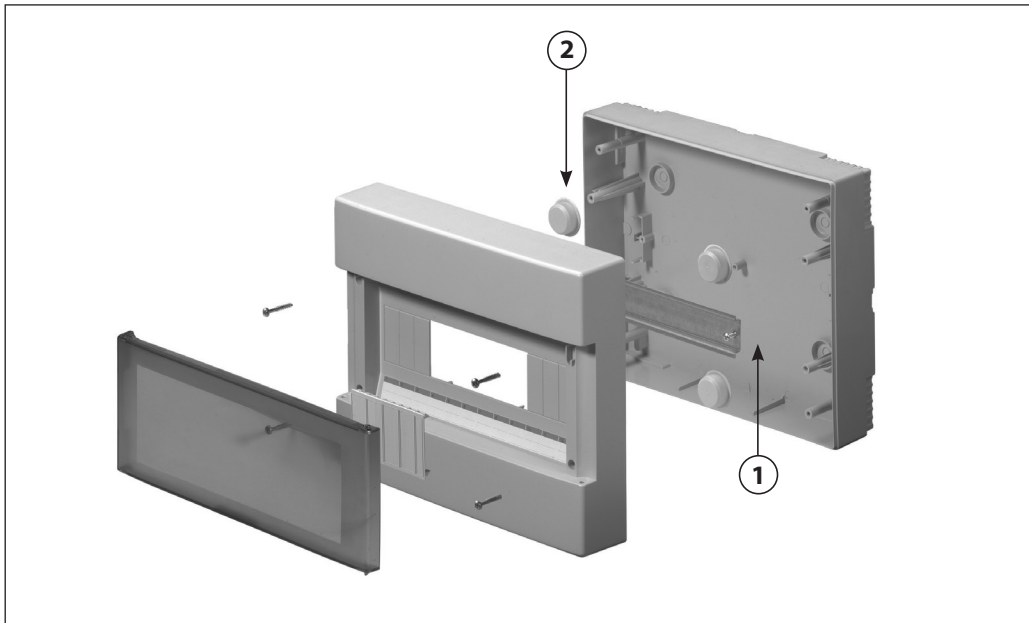

1
Possibilità di installare apparecchi con profondità di 48 o 75 mm.
Possibility to install equipments with a depth of 48 or 75 mm.
Capacité d'installer appareilles avec une profondeur de 48 ou 75 mm.
Posibilidad de instalar equipos de 48 ó 75 mm.

2
Copertura per moduli e tappi copri fori di fissaggio a garanzia del doppio isolamento.

Blank cover for empty modules and plastic caps for the holes of the fixing screws in the back to gain double insulation.

Couverture pour les modules couvre-chaussure couvre des trous de fixation et de veiller à ce double isolation.

Tapa cubre módulos y tapones de plástico para las fijaciones por tal de garantizar el doble aislamiento.

Serie 600 - 610

Caratteristiche tecniche
Technical features
Cahier des charges
Características técnicas

Riferimenti normativi: EN 60670-1/24

Idoneo a essere montato con isolamento completo.

Tensione nominale: 400 V - Corrente nominale: max. 125A - Involucri di tipo GP.

Ingresso conduttori mediante tubi fino a 40 mm.

Possibilità di installare apparecchi con profondità di 48 o 75 mm.

Porta smontabile, frontale reversibile.

Gamma da 2 a 72 moduli DIN EN 50022.

Reference Standards: EN 60670-1/24

Suitable to be mounted with complete insulation.

Nominal voltage: 400 V - Nominal current: max. 125A - GP type enclosures.

Conductor inlet through conduits up to 40 mm.

Possibility to install equipments with a depth of 48 or 75 mm

Removable door, reversing front.

Range from 2 to 72 modules according to DIN EN 50022.

Références normatives: EN 60670-1/24

Convient à être équipé d'un isolement complet.

Tension nominale: 400 V - Courant nominal: max. 125A - Coffret de type GP.

Entrée par le biais de conducteurs tubes jusqu'à 40 mm.

Capacité d'installer appareilles avec une profondeur de 48 ou 75 mm

Porte amovible, devant réversible.

Gamme de 2 à 72 modules DIN EN 50022.

Referencia normativa: EN 60670-1/24

Idóneo para ser montado con aislamiento completo.

Tensión Nominal: 400 V - Corriente nominal: máx. 125A - Cuadros de tipo GP.

Entrada de cables por medio de conducto de hasta 40 mm de diámetro.

Posibilidad de instalar equipos de 48 ó 75 mm.

Puerta desmontable, frontal reversible.

Gama de 2 a 72 módulos DIN EN 50022.